

REDEFINING HAND PROTECTION

CATALOGUE 2021



HAND PROTECTION WITHOUT COMPROMISE

OUR HANDS ARE OUR MOST IMPORTANT TOOL AND AT THE HEART OF WONDER GRIP®: WE WANT TO PROTECT THEM FROM COLD, HEAT, CUTS, WATER, CHEMICALS AND OILS IN TODAY'S INCREASINGLY COMPLEX WORKING WORLD - WITH INNOVATIVE GLOVES THAT COMPLETELY REDEFINE SAFETY.

CONTENT

The formula for maximum safety	4
Protection according to EU standards	6
The building blocks of perfect protection	8
Technologies of Wonder Grip®	10

COLD RESISTANCE 12

Thermo Lite	WG-320	14
Thermo	WG-380	14
Freeze Flex Plus	WG-538	15
All models at a glance / Legend		16

GENERAL HANDLING 18

Rock & Stone	WG-333	20
Rock & Stone	WG-333+	20
Bee-Tough	WG-522	21
Bee-Smart	WG-422	21
Duo	WG-555	22
Comfort Lite	WG-300	22
Dual	WG-355	23
U-Feel	WG-1855HY	24
Comfort	WG-310	25
Flex	WG-500	25
Opty™	OP-650	26
Opty™	OP-1300	26
Opty™	OP-280	26
All models at a glance / Legend		27

CUT RESISTANCE 30

Dexcut®	WG-718	33
Dexcut®	WG-733	33
Dexcut®	WG-733+	34
Dexcut®	WG-780	34
Dexcut®	WG-788	35
Opty™	OP-775	35
Opty™	OP-795	36
All models at a glance / Legend		36

WATER RESISTANCE 38

Aqua	WG-318	40
Legend		41

CHEMICAL RESISTANCE 42

Dexcut®	WG-758L	44
Opty™	OP-600L	45
All models at a glance / Legend		46

INDUSTRIAL OIL RESISTANCE 48

Oil	WG-510	48
Oil Guard	WG-528L	49
All models at a glance / Legend		50

THE FORMULA FOR MAXIMUM SAFETY

For us, safety means protection plus dexterity plus grip: Wonder Grip® gloves reliably protect the hands, provide grip and are at the same time so flexible that the fingers can move freely. This ensures that our customers have everything safely under control - and no reason to put their gloves aside.



PROTECTION

We want to offer our customers gloves that protect them safely in every task. That's why we are always researching new materials and coatings, developing our models further and controlling every step of production - without compromise. As a result, our products meet all important standards.



DEXTERITY

Our customers can work particularly well with precisely fitting, flexible gloves. All models therefore have the ergonomic shape of a resting hand. Their material has been washed three times and thus feels impressively soft. At the same time, an exceptionally high knitted cuff provides more support.

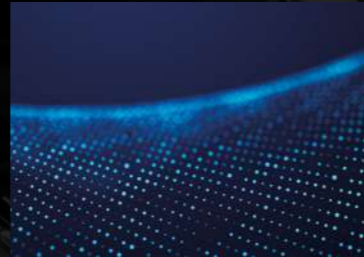

GRIP

A surface with microscopic suction cups or latex with particularly high fabric density - our innovative coatings ensure maximum grip. As a result, Wonder Grip® gloves save strength, reduce ergonomic stress and injuries. Muscles tire more slowly and productivity increases.



OUR FACTORY

Our factory, located in Dongtai, China, has acquired ISO 9001, ISO 14001 and OHSAS 18001 certifications. All the production processes - from raw materials to the final product - are managed at high standards. Our factory possesses the latest production facility to maintain a continuous supply of products of the highest quality.

ISO 9001

Our ISO 9001 certification means that our organisation satisfies all prerequisite conditions for an efficient and appropriate quality management system. Wonder Grip's policy towards continuous improvement enables us to guarantee that our products are manufactured according to strict quality requirements.

ISO 14001

ISO 14001 certification is an internationally renowned standard for corporate environmental management. Thanks to Wonder Grip's advanced EMS system, we can control our impact on the environment. ISO 14001 certification is accredited by UKAS.

OHSAS 18001

Wonder Grip has achieved OHSAS 18001 accreditation thanks to its commitment to building a greener future, respectful of the safety and the well-being of all its staff members and their families.

PROTECTION ACCORDING TO EU STANDARDS

Wonder Grip® gloves meet all important EU standards. This is confirmed by tests in an independent European laboratory. How strong the protection is against cold, heat, cuts, chemicals and more is shown by different performance levels and codes. Basically, the higher the value, the stronger the protection.

IMPORTANT INFORMATION

The pictogram indicates that the user has to consult the Instructions of use.

EN 420:2003 + A1:2009 GENERAL REQUIREMENTS

Content of the standard:

- Ergonomics
- Comfort due to the right size
- Harmlessness
- Construction, i.e. pH between 3.5 and 9.5, less than 3 mg/kg chromium, no allergenic substances
- Electrostatic properties according to EN 16350:2014 and test method 5.5 from EN 1142:1997 section 7

EN 388:2016 PROTECTION AGAINST PHYSICAL AND MECHANICAL RISKS

TEST / PERFORMANCE LEVEL	0	1	2	3	4	5
a. Abrasion resistance (cycles)	<100	100	500	2000	8000	-
b. Circular blade cut resistance (factor)	<1.2	1.2	2.5	5.0	10.0	20.0
c. Tear resistance (newton)	<10	10	25	50	75	-
d. Puncture resistance (newton)	<20	20	60	100	150	-
TEST / PERFORMANCE LEVEL	A	B	C	D	E	F
e. Straight blade cut resistance (newton)	2	5	10	15	22	30
f. Impact resistance (5J)	Pass = P / fail or not performed = no mark					

Abrasion resistance (0-4), circular blade cut resistance (0-5), tear resistance (0-4), puncture resistance (0-4), straight blade cut resistance (A-F) and impact resistance (P or no mark)

EN 388:2003 Now EN 388:2016 - What's new?

Some gloves are still tested according to the EN 388:2003 standard. This does not make them any less safe. New in the EN 388:2016 standard are details in the test methods and markings:

- **Abrasion:** new abrasive paper is used for the test
- **Cut:** new standard EN ISO 13997, also known as the TDM-100 test. The letters A to F indicate how cut-resistant the glove is after the test
- **Impact:** new test method
- **New** marking with 6 performance levels



The American National Standards Institute identifies even higher protection classes. Some models are therefore additionally certified according to ANSI.

THE RIGHT GLOVE SIZE FOR EVERY HAND LENGTH

HAND WIDTH	SIZE
11 cm	11 / XXL
10 cm	10 / XL
9 cm	9 / L
8 cm	8 / M
7 cm	7 / S
6 cm	6 / XS

EN 511:2006 PROTECTION AGAINST COLD

Content of the standard: How well does the glove protect against convective, i.e. penetrating cold and contact cold? What is the water permeability after 30 minutes?

TEST / PERFORMANCE LEVEL	
a. Protection against convective cold	0-4
b. Protection against contact cold	0-4
c. Water impermeability	0 or 1
Level 1 was not reached	0
Test was not performed	X

ISO 13997 RISK CLASSES FOR CUT PROTECTION

The ISO cut resistance test divides gloves into four risk levels:

TEST / PERFORMANCE LEVEL	RISK CLASSES	TYPE OF GLOVE
A	Very low risk	multi-purpose gloves
B & C	Medium risk	gloves with medium cut resistance
D	High risk	Gloves with high cut resistance
E & F	Specific applications and very high risk	Robust gloves with very high cut resistance

EN 407:2004 PROTECTION AGAINST HEAT

Content of the standard: does the glove meet the minimum requirements in terms of thermal risks?

TEST / PERFORMANCE LEVEL	
a. Resistance to flammability (in seconds)	0-4
b. Resistance to contact heat	0-4
c. Resistance to convective heat	0-4
d. Resistance to radiant heat	0-4
e. Resistance to small splashes of molten metal	0-4
f. Resistance to large splashes of molten metal	0-4
Level 1 was not reached	0
Test was not performed X	X

EN 374-1:2016 CHEMICAL PROTECTION

Content of the standard: To what extent do 18 certain chemicals decompose or penetrate a glove?

Not considered: Duration of protection in the workplace. Differences between pure and mixed chemicals - mixtures often react unpredictably.

Penetration

Chemicals can penetrate through holes and other defects in the glove material. The requirements for a chemical glove: In the penetration test according to EN 374-2:2014, neither water nor air escape from the glove.

Degradation

The instructions for use shall state the percentage by which certain chemicals degrade the glove in accordance with EN 374-4:2013.

Permeation

Chemicals permeate the glove material at the molecular level.

EN 374-5:2016 PROTECTION AGAINST MICRO-ORGANISMS

Various tests are necessary for labeling on the package.

- **For protection against bacteria** and fungi: penetration test for air and water tightness according to the method of EN 374-2:2014.
- **For protection against viruses:** ISO 16604:2004 standard (method B).

PROTECTION	METHOD
Protection against bacteria and fungi	Penetration test for air and water tightness according to the method of EN 374-2:2014
Protection against viruses	Standard ISO 16604:2004 (method B)

CODE	CHEMICAL	CAS NO.	CLASS
A	Methanol	67-56-1	Primary alcohol
B	Acetone	67-64-1	Ketone
C	Acetonitrile	75-05-8	Nitrile compound
D	Dichloromethane	75-09-2	Chlorinated hydrocarbon
E	Carbon disulphide	75-15-0	Sulphur containing organic compound
F	Toluene	108-88-3	Aromatic hydrocarbon
G	Diethylamine	109-89-7	Amine
H	Tetrahydrofuran	109-99-9	Heterocyclic and ether compound
I	Ethyl acetate	141-78-6	Ester
J	n-Heptane	142-82-5	Saturated hydrocarbon
K	Sodium hydroxide 40%	1310-73-2	Inorganic base
L	Sulphuric acid 96%	7664-93-9	Inorganic mineral acid, oxidizing
M	Nitric acid 65%	7697-37-2	Inorganic mineral acid, oxidizing
N	Acetic acid 99%	64-19-7	Organic acid
O	Ammonium Hydroxide 25%	1336-21-6	Organic base
P	Hydrogen peroxide 30%	7722-84-1	Peroxide
S	Hydrofluoric acid 40%	7664-39-3	Inorganic mineral acid
T	Formaldehyde 37%	50-00-0	Aldehyde

THE BUILDING BLOCKS OF PERFECT PROTECTION

Some models provide particularly good protection against chemicals. Others remain flexible even in extreme cold. The decisive factor for the strengths of each Wonder Grip® glove is how it is woven and coated.

THE MESH DENSITY: GAUGE

Gauge simply means: how many meshes fit on one cm²? Wonder Grip® gloves have very different gauge numbers - matched to the area they are made for: Models for very rough work tend to have fewer and coarser meshes. This keeps the hands pleasantly cool. Gloves for precision work, on the other hand, are knitted with a very high stitch density and a rather thin thread. This allows the fingers to move more freely and gives them a better sense of touch.

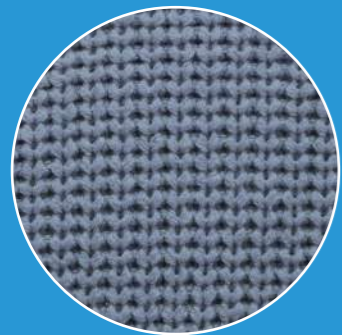

COARSE KNIT
GAUGE 10

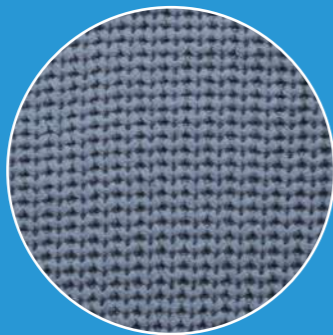

MEDIUM KNIT
GAUGE 13-15

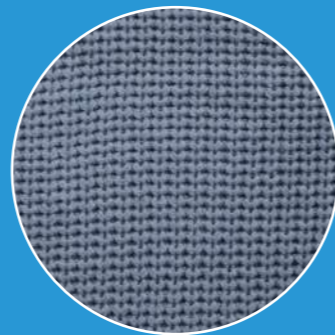

FINE KNIT
GAUGE 18

THE COATING

Nitrile is very robust and strong against chemicals, latex has excellent grip even in the wet and polyurethane allows the skin to breathe optimally. Each coating has its own strengths. We therefore use them specifically depending on the type of protective glove.



NITRILE

- HIGH ABRASION RESISTANCE
- HIGH ROBUSTNESS
- VERY GOOD RESISTANCE TO CHEMICALS, OILS AND GREASES



LATEX

- VERY GOOD GRIP
- HIGH ELASTICITY AND TEARABILITY
- WATERPROOF, OPTIMAL FOR WORK EVEN IN WET ENVIRONMENTS



POLYURETHANE (PU)

- HIGH BREATHABILITY
- GOOD GRIP
- GOOD RESISTANCE TO CHEMICALS, OILS AND GREASES

TECHNOLOGIES

The DNA of Wonder Grip®: research, development and innovation

Completely new mixing ratios for coatings, revolutionary weaving techniques and an exceptionally ergonomic shape. Unique and patented innovations make Wonder Grip® gloves particularly safe, flexible and comfortable to wear.



SZNT™ SUB-ZERO NITRILE TECHNOLOGY

Made for working below freezing. Gloves coated with Sub-Zero Nitrile Technology™ remain flexible, grippy, tear-resistant and reliably protect against industrial oils even at temperatures as low as -20 °C.



TPDT™ THERMO-SET PRE-CURVED DESIGN TECHNOLOGY

To ensure that every glove is a perfect fit, our mold mimics the natural posture of the hand. For more freedom of movement and the typical Wonder Grip® tactile feel, we wash and dry them with a revolutionary method.



WONDER GRIP TECHNOLOGY™

More grip means: Our customers need less force to move objects. Wonder Grip Technology™ creates bumps on the surface that act like suction cups. For 58% more grip with latex coatings. 36% for nitrile coatings. According to tests by BOKEN Japan.



XTENDED PERFORMANCES XPI™

The smooth coating is particularly flexible, wears slowly and has excellent grip in dry environments.



TOUCH SCREEN

A special coating also allows devices with touchscreens to be operated - with safely protected hands.



WONDER GRIP PERFORMANCE™

A remarkably thin and smooth protective layer. Exceptional tactile feel at the fingertips and more dexterity. The special nitrile coating with the Wonder Grip Performance™ formula completely eliminates latex and silicone. Optimal for maximum controlled work in dry environments.



DUALINER™

With the DuaLiner™ lining, nerves, tendons and muscles tire more slowly - and stay healthy; the fibers of the upper part feel like a second skin and are almost as flexible. The lower part up to the middle of the hand provides firm, secure support. This prevents hand fatigue and inflammation of joints and tendons thanks to innovative and proprietary nylon construction.



BEE-SERIES™

The revolutionary Bee-series™ knitting technology is inspired by honeycombs. The result: an ultra-light lining that can absorb a lot of weight - and at the same time is twice as breathable* as normally knitted linings. Another advantage: the palms are particularly grippy.

*Diameter 10 mm, 300 pa, 2857.6 mm/s vs. 1503.6 mm/s



HDML™ HIGH DENSITY MOLECULAR LATEX

With High Density Molecular Latex™, different substances are combined in such a way that the amount of substance is particularly concentrated - more than with the conventional latex formula. The result: less wear. Lots of grip for less fatigue.



Safer than many competing products, in production and with our customers: all gloves are made from high-quality raw materials - without toxic solvents - confirmed by OEKO-TEX®.



Maximum protection for the health of our employees and the environment: all raw materials comply with REACH - the EU regulation for the registration, evaluation, authorization and restriction of chemicals.



The material of our cut-resistant gloves: The polyethylene fiber of the Japanese company Toyobo is extremely resistant and at the same time soft and comfortable to wear. It absorbs body heat particularly well and distributes it naturally - for a feeling of freshness. Made without solvents, it is more hygienic and healthier than other polyethylene fibers.



COLD RESISTANCE

Safe in freezing environments and resistant to contact cold. The special cold protection of our gloves builds up layer by layer. The basis: knitted acrylic. It keeps hands warm and leaves no residue after wearing. A double coating provides special protection. Some models remain flexible and comfortable even at temperatures as low as -20°C , thanks to an innovative nitrile coating.

TYPE OF PROTECTION

COLD RESISTANCE, HEAT RESISTANCE
CUT RESISTANCE, LIQUIDS

INDUSTRIES

FOOD INDUSTRY
CIVIL ENGINEERING
FORKLIFT TRUCK OPERATION
PUBLIC INSTITUTIONS
WATER RESOURCES MANAGEMENT
INDUSTRY
LOGISTICS
WASTE TREATMENT
REFRIGERATED TRANSPORT AND STORAGE
AGRICULTURAL WORK





WG-320 THERMO LITE

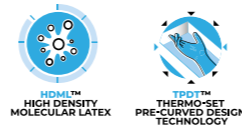

The WG-320 Thermo Lite is a protective glove with double latex coating on a 13 gauge brushed acrylic and spandex lining. The acrylic provides additional insulation for cold protection, while the spandex ensures lasting flexibility, fit and comfort. The WG-320 Thermo Lite is the glove of choice for all users who want the best fit and dexterity plus superior comfort while keeping their hands nice and warm.

TYPE OF PROTECTION	APPLICATION	INFORMATION	
- General handling - Cold resistance	INDUSTRIES Agrifood, construction and public works, forklift truck operation, public authorities, industry, logistics, waste treatment, refrigerated transport and storage, agricultural work	COATING - Material: latex - Type: double, palm fit	SUPPORT MATERIAL - Gauge: 13 - Spandex - Acrylic - Color: orange
NORMS		SIZES	PACKAGING
EN388: 2016 2131X EN511: 2006 X1X 		With tag: 8/M; 9/L; 10/XL; 11/XXL No tag: 7/S; 8/M; 9/L; 10/XL; 11/XXL	- 1 pair/polybag 144 pairs/box - 12 pairs/polybag 144 pairs/box 5,99 / 71,99



WG-538 FREEZE FLEX PLUS



The WG-538 Freeze Flex Plus is Wonder Grip's® latest innovation in cold-resistant hand protection. The glove is fully double coated and cold resistant (contact cold performance level 2) keeping your hands warm down to -20 °C. Using the specifically developed innovative SNZT™ nitrile coating, the WG-538 Freeze Flex Plus remains flexible and comfortable even at temperatures below freezing, while providing maximum abrasion resistance.

TYPE OF PROTECTION	APPLICATION	INFORMATION	
- Cold resistance	INDUSTRIES Agrifood, construction and public works, forklift truck operation, public authorities, industry, logistics, waste treatment, refrigerated transport and storage, agricultural work	COATING - Material: nitrile - Type: triple, fully dipped, knit wrist	SUPPORT MATERIAL - Gauge: 13 - Polyester - Color: blue
NORMS		SIZES	PACKAGING
EN388: 2016 4131X EN511: 2006 X2X 		With tag: 8/M; 9/L; 10/XL; 11/XXL No tag: 7/S; 8/M; 9/L; 10/XL; 11/XXL	- 1 pair/polybag 72 pairs/box - 12 pairs/polybag 72 pairs/box 9,99 / 119,99



WG-380 THERMO

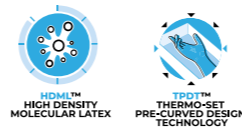

The WG-380 Thermo is a glove with double latex coating and a 10 gauge acrylic inner lining. The napped acrylic liner makes the hands feel warmer in cold conditions. Offering EN 511 level 1 cold resistance, the WG-380 Thermo can be used in freezing environments.

TYPE OF PROTECTION	APPLICATION	INFORMATION	
- Cold resistance	INDUSTRIES Agrifood, construction and public works, forklift truck operation, public authorities, aquatic resource management, industry, logistics, waste treatment, refrigerated transport and storage, agricultural work	COATING - Material: latex - Type: double, palm fit	SUPPORT MATERIAL - Gauge: 10 - Acrylic - Color: orange
NORMS		SIZES	PACKAGING
EN388: 2016 2241X EN511: 2006 X1X 		With tag: 7/S; 8/M; 9/L; 10/XL; 11/XXL No tag: 7/S; 8/M; 9/L; 10/XL; 11/XXL	- 1 pair/polybag 72 pairs/box - 12 pairs/polybag 72 pairs/box 6,99 / 83,99



ALL MODELS AT A GLANCE



WG-320



WG-380



WG-538

PROTECTION	General handling	✓		
	Cut resistance			
	Liquids			✓
	Industrial oils			✓
	Cold	✓	✓	✓
	Heat			
	Chemicals			
	Cut resistance level B	✓		
	Cut resistance level C			
	Cut resistance level D			
NORMS	EN 388:2016	2131X	2241X	4131X
	EN 511:2006		X1X	X2X
	EN 407:2004			✓
	EN 374:2016			
	Suitable for handling food			✓

LEGEND

NORMS

EN 388:2016
Protection against physical and mechanical risks

EN 511:2006
Protection against cold

EN 407:2004
Protection against thermal risks

EN 374:2016
Protection against chemicals

CUT RESISTANCE

Level A:
High risk

Level B & C:
Medium risk

Level D:
Low risk

Level E & F:
Specific applications and very low risk

MATERIALS

LTX: latex
NBR: nitrile

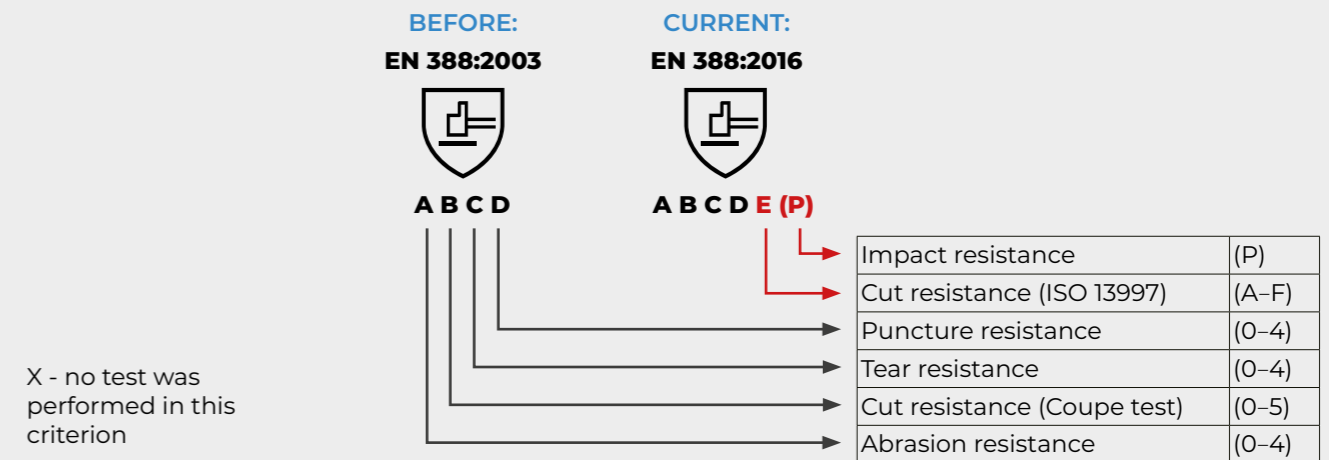

DIN EN 511: PROTECTION AGAINST COLD

DIN EN 511 regulates the protection of hands against cold. A distinction is made between convective cold (penetrating cold) and contact cold (e.g. through direct contact with cold objects). The waterproofness is also tested.

The higher the digit, the better the test result.

EN 511



2 3 1

Test criteria	Performance level
Convective cold	Level 0-4
Contact cold	Level 0-4
Watertightness	Level 0-1

THERMAL RISKS

The higher the digit, the better the test result.

EN 407



3 1 2 1 X 2

Test criteria	Performance level
Burning behavior	Level 0-4
Contact heat	Level 0-4
Convective heat	Level 0-3
Radiant heat	Level 0-4
Exposure to small splashes of molten metal	Level 0-4
Exposure to big splashes of molten metal	Level 0-4



GENERAL HANDLING

Innovative coatings distribute heat efficiently and therefore, keep the hands pleasantly cool and sweat-free. An exceptionally flexible material mix gives the fingers maximum freedom of movement and tactile sensitivity. Revolutionary protective coatings reliably shield temperatures or allow the use of touchscreens. Our all-rounders protect for fine to heavy work. Each model has its own special strengths.

TYPE OF PROTECTION

CUT RESISTANCE, COLD RESISTANCE, HEAT RESISTANCE

INDUSTRIES

AGRICULTURE
SELF-EMPLOYED TRADES
CONSTRUCTION AND PUBLIC WORKS
PUBLIC AUTHORITIES
CONSTRUCTION
ROAD MAINTENANCE
GREEN SPACES
AGRICULTURAL INDUSTRY

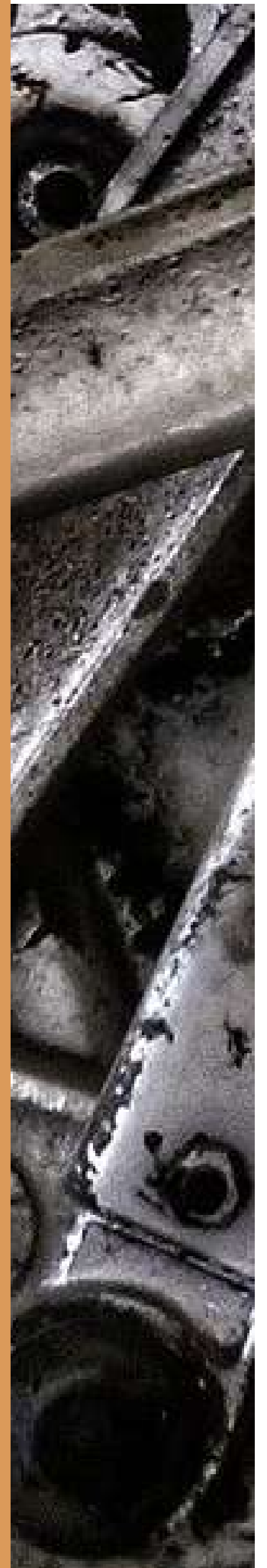



WG-333 ROCK & STONE

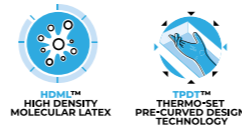

The WG-333 Rock & Stone is a glove with a double latex coating on a 10 gauge cotton and polyester liner. The HDML™ coating, specially developed by Wonder Grip®, offers a non-slip surface for excellent grip. This unique product is designed specially for heavy-duty work. It is particularly robust and at the same time protects against heat, cold and cuts (Level B ISO 13997).

TYPE OF PROTECTION	APPLICATION	INFORMATION	
- General handling - Cut resistance - Cold resistance - Heat resistance	INDUSTRIES Agriculture, self-employed trades, construction and public works, public authorities, construction, road maintenance, green spaces, agricultural industry	COATING - Material: latex - Type: double, palm fit	SUPPORT MATERIAL - Gauge: 10 - Cotton - Polyester - Color: grey
NORMS		SIZES	PACKAGING
EN388: 2016 3X42B EN511: 2006 X1X EN407: 2004 X2XXXX 		With tag: 7/S; 8/M; 9/L; 10/XL; 11/XXL No tag: 7/S; 8/M; 9/L; 10/XL; 11/XXL	- 1 pair/polybag 144 pairs/box - 12 pairs/polybag 144 pairs/box
			RRP € 4,99 59,99



WG-522 BEE-TOUGH



The WG-522 Bee-Tough combines Bee-series™ knitting technology and a nitrile coating to provide oil-resistance and an optimal long-lasting grip. The upper part of the glove is made of an ultralightweight liner offering both high resistance to torsion and unmatched breathability. The Bee-series™ knitting technology creates a unique shape on the palm and maximizes the friction coefficient of the coating. The lower part of the glove benefits from the Dualiner™ technology and its special support on the back of the hand ensuring a snug and secure fit. Featuring Bee-series™, Dualiner™ and a nitrile coating, the WG-522 Bee-Tough sets new standards in working comfort in greasy and oily environments.

TYPE OF PROTECTION	APPLICATION	INFORMATION	
- General handling - Heat resistance	INDUSTRIES Logistics, maintenance, assembly and installation in dry and slightly oily environments, construction and public works, road maintenance	COATING - Material: nitrile - Type: single, palm fit	SUPPORT MATERIAL - Gauge: 13 - Polyester - Color: blue & light, blue
NORMS		SIZES	PACKAGING
EN388: 2016 4121X EN407: 2004 X1XXXX 		With tag: 8/M; 9/L; 10/XL; 11/XXL No tag: 7/S; 8/M; 9/L; 10/XL; 11/XXL	- 1 pair/polybag 144 pairs/box - 12 pairs/polybag 144 pairs/box
			RRP € 4,99 59,99



WG-333+ ROCK & STONE

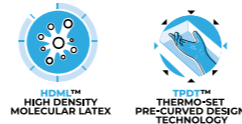

The WG-333+ Rock & Stone is a glove with a double latex coating on a 10 gauge cotton and polyester lining. The HDML™ coating, specially developed by Wonder Grip®, provides a non-slip surface for excellent grip. This unique product is specifically designed for heavy duty work. It is particularly robust and at the same time protects against heat, cold and cuts (Level B ISO 13997).

TYPE OF PROTECTION	APPLICATION	INFORMATION	
- General handling - Cut resistance - Cold resistance - Heat resistance	INDUSTRIES mechanical engineering, construction and public works, Landscaping, Logistics	COATING - Material: Latex - Type: single, palm fit	SUPPORT MATERIAL - Gauge: 10 - Cotton - Polyester - Color: grey & red
NORMS		SIZES	PACKAGING
EN388: 2016 3X42B EN511: 2006 X1X EN407: 2004 X2XXXX 		With tag: 7/S; 8/M; 9/L; 10/XL; 11/XXL No tag: 7/S; 8/M; 9/L; 10/XL; 11/XXL	- 1 pair/polybag 144 pairs/box - 12 pairs/polybag 144 pairs/box
			RRP € 6,99 83,99



WG-422 BEE-SMART

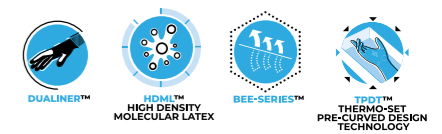

WG-422 Bee-Smart encapsulates our brand-new Bee-series™ knitting technology and our new generation of latex in-house developed, the HDML™ coating. The upper part of the gloves is made of an ultra lightweight liner offering both high resistance to torsion and unmatched breathability. The Bee-series™ knitting technology creates a unique shape on the palm maximizing the friction coefficient of the coating. The lower part of the glove benefits from the Dualiner™ technology and its special support on the back of the hand ensuring a snug and secure fit. The WG-422 Bee-Smart sets new standards in comfort, making it the ultimate glove for general handling work.

TYPE OF PROTECTION	APPLICATION	INFORMATION	
- General handling - Heat resistance	INDUSTRIES Logistics, maintenance, self-employed trades, construction and public works, road maintenance, green spaces, part sorting, machine tooling, forklift truck operation	COATING - Material: latex - Type: single, palm fit	SUPPORT MATERIAL - Gauge: 13 - Polyester - Color: black & blue
NORMS		SIZES	PACKAGING
EN388: 2016 3131X EN407: 2004 X1XXXX 		With tag: 7/S; 8/M; 9/L; 10/XL; 11/XXL No tag: 7/S; 8/M; 9/L; 10/XL; 11/XXL	- 1 pair/polybag 144 pairs/box - 12 pairs/polybag 144 pairs/box
			RRP € 4,99 59,99



WG-555 Duo

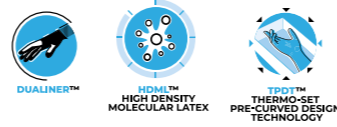

The WG-555 Duo is based on our innovative Dualiner™: the nylon knit cuff extends to the center of the hand for a snug and secure fit, while the breathable knit microfiber lining at the knuckles and fingertips provides superior softness, dexterity and precision. The WG-555 Duo's breathable foam nitrile coating helps keep your hands dry and provides excellent grip in a variety of applications, so users can easily tackle daily work challenges.

TYPE OF PROTECTION	APPLICATION	INFORMATION	
- General handling	INDUSTRIES Aerospace, assembly and installation in dry and slightly oily environments, automotive industry, mechanical industry, maintenance	COATING - Material: nitrile - Type: single, palm fit	SUPPORT MATERIAL - Gauge: 15 - Nylon - Microfibre - Color: grey & black
NORMS	SIZES	PACKAGING	RRP €
EN388: 2016 4121X 	With tag: 8/M; 9/L; 10/XL; 11/XXL No tag: 7/S; 8/M; 9/L; 10/XL; 11/XXL	- 1 pair/polybag 144 pairs/box - 12 pairs/polybag 144 pairs/box	5,99 71,99



WG-300 COMFORT LITE

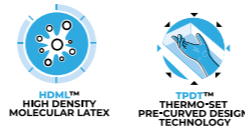

The WG-300 Comfort Lite is our high-quality entry-level latex product. With a single latex coating on a 15 gauge nylon and polyester lining, the WG-300 Comfort Lite offers great elasticity for easier hand movements and more dexterity when performing precise work tasks.

TYPE OF PROTECTION	APPLICATION	INFORMATION	
- General handling	INDUSTRIES Aeronautical, self-employed trades, construction and public works, forklift truck operation, electronics, logistics, handling and assembly in dry or slightly damp environments	COATING - Material: latex - Type: single, palm fit	SUPPORT MATERIAL - Gauge: 15 - Polyester - Nylon - Color: green
NORMS	SIZES	PACKAGING	RRP €
EN388: 2016 2131X 	With tag: 7/S; 8/M; 9/L; 10/XL; 11/XXL No tag: 7/S; 8/M; 10/XL;	- 1 pair/polybag 144 pairs/box - 12 pairs/polybag 144 pairs/box	4,99 59,99



WG-355 DUAL



The WG-355 Dual is based on a brand new double-knit support material: The nylon material, which encloses the wrist and the hand up to the the wrist and hand up to the base of the fingers. At the fingers and finger bones, on the other hand the support material is made of microfibre, which ensures outstanding dexterity, unparalleled comfort and tactile sensitivity. The single latex coating of the WG-355 Dual contributes to a better grip.

TYPE OF PROTECTION	APPLICATION	INFORMATION	
- General handling	INDUSTRIES Construction and public works, construction, logistics, electrical installation, aerospace, forklift truck operation	COATING - Material: Latex - Type: single, palm fit	SUPPORT MATERIAL - Gauge: 15 - Nylon - Microfibre - Color: orange
NORMS	SIZES	PACKAGING	RRP €
EN388: 2016 2131X 	With tag: 7/S; 8/M; 9/L; 10/XL; 11/XXL No tag: 7/S; 8/M; 9/L; 10/XL; 11/XXL	- 1 pair/polybag 144 pairs/box - 12 pairs/polybag 144 pairs/box	5,99 71,99





WG-1855HY U-Feel



The WG-1855HY U-Feel is a glove with a single nitrile coating on an 18 gauge polyester and spandex lining. Our Wonder Grip Performance™ dipping offers an outstanding thin and smooth protective coating, delivering incomparable levels of sensitivity and dexterity at the fingertips. Incredibly thin and soft, it gives users a second skin feeling, providing exceptional comfort and maximum precision for work where accuracy is essential. The WG-1855HY model is certified silicone-free.

TYPE OF PROTECTION	APPLICATION	INFORMATION		
- General handling - Heat resistance	INDUSTRIES Aerospace, self-employed trades, assembly, automotive industry, public authorities, electronics, finishing and inspection, industry, logistics, maintenance, installation	COATING - Material: nitrile - Type: single, palm fit	SUPPORT MATERIAL - Gauge: 18 - Polyester - Spandex - Color: «Hi-Viz» yellow	
NORMS		SIZES	PACKAGING	RRP €
EN388: 2016 4121X EN407: 2004 X1XXXX 		With tag: 7/S; 8/M; 9/L; 10/XL; 11/XXL No tag: 7/S; 8/M; 9/L; 10/XL; 11/XXL	- 1 pair/polybag 144 pairs/box - 12 pairs/polybag 144 pairs/box	4,99 59,99



WG-310 COMFORT

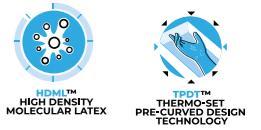

The WG-310 Comfort is a glove with a single latex coating on a 13 gauge polyester lining. Thanks to Wonder Grip Technology™, the coating provides excellent grip and resistance in dry and slightly wet environments.

TYPE OF PROTECTION	APPLICATION	INFORMATION		
- General handling	INDUSTRIES Aerospace, self-employed trades, construction and public works, forklift truck operation, electronics, logistics, handling and assembly in dry or slightly damp environments	COATING - Material: latex - Type: single, palm fit	SUPPORT MATERIAL - Gauge: 13 - Polyester - Color: yellow, red orange	
NORMS		SIZES	PACKAGING	RRP €
EN388: 2016 2131X 		yellow: With tag: 7/S; 8/M; 9/L; 10/XL; 11/XXL No tag: 7/S; 8/M; 9/L; 10/XL; 11/XXL orange: With tag: 7/S; 8/M; 9/L; 10/XL; 11/XXL No tag: 7/S; 8/M; 9/L; 10/XL; 11/XXL red: With tag: 7/S; 8/M; 9/L; 10/XL; 11/XXL No tag: 8/M; 9/L; 10/XL; 11/XXL	- 1 pair/polybag 144 pairs/box - 12 pairs/polybag 144 pairs/box	4,99 59,99



WG-500 FLEX

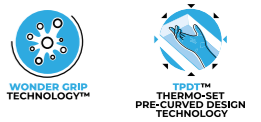

The WG-500R Flex is a glove with a single nitrile coating on a 13 gauge nylon lining. This cost-effective solution with Wonder™ nitrile and microfoam coating provides exceptional grip and comfort for tasks such as parts assembly and warehouse handling. The WG-500R Flex is an excellent all-purpose glove and performs well in wet, slightly oily and dry conditions.

TYPE OF PROTECTION	APPLICATION	INFORMATION		
- General handling	INDUSTRIES Aerospace, mechanical industry, assembly, automotive industry, storage, packaging, logistics	COATING - Material: Nitril - Type: palm fit	SUPPORT MATERIAL - Gauge: 13 - Nylon - Color: red	
NORMS		SIZES	PACKAGING	RRP €
EN388: 2016 4131X 		With tag: 7/S; 8/M; 9/L; 10/XL; 11/XXL No tag: 7/S; 8/M; 9/L; 10/XL; 11/XXL	- 1 pair/polybag 144 pairs/box - 12 pairs/polybag 144 pairs/box	4,99 59,99



OP-650 OPTX™



The Wonder Grip® OP-650 is an ultra-lightweight palm-coated nitrile glove designed specifically for assembly and maintenance operations. The OP-650's nitrile coating ensures complete protection from fluids such as industrial oils while providing maximum dexterity.

TYPE OF PROTECTION		APPLICATION	INFORMATION	
- General handling		INDUSTRIES Aerospace, automotive, storage, packaging and logistics, construction and public works, assembly	COATING - Material: nitrile - Type: single, palm fit	SUPPORT MATERIAL - Gauge: 13 - Polyester - Color: white, black, red
NORMS		SIZES	PACKAGING	RRP €
EN388: 2016 4121X		With tag: 7/S; 8/M; 9/L; 10/XL; 11/XXL No tag: -	- 1 pair/polybag 144 pairs/box - 12 pairs/polybag 144 pairs/box	3,99



OP-1300 OPTX™



Wonder Grip® Opty™ OP-1300G is our ultra-thin PU protective glove. Our Xtended Performances XP!™ PU coating provides superior comfort, protection and dexterity. The extra thin and flexible coating offers such a comfortable wear that it feels like a second skin in combination with an outstanding grip.

TYPE OF PROTECTION		APPLICATION	INFORMATION	
- General handling		INDUSTRIES Assembly work, packaging, logistics, automotive, construction and public works, airport, mechanical engineering, öffentliche Behörden	COATING - Material: PU, - Type: single, palm fit	SUPPORT MATERIAL - Gauge: 13 - Nylon - Color: blue, grey
NORMS		SIZES	PACKAGING	RRP €
EN388: 2016 4141X		With Tag: 7/S; 8/M; 9/L; 10/XL; 11/XXL Ohne Tag: 7/S; 8/M; 9/L; 10/XL; 11/XXL	- 1 Paar/PKG. 144 Paare/Box - 12 Paare/PKG. 144 Paare/Box	2,99 38,99



OP-280 OPTX™



The OP-280 is a very thin latex glove for general handling. Due to its high flexibility and robustness, it offers great dexterity, improved comfort and excellent grip in wet and dry environments. The liner material of our OP-280 is made of neon colored polyester (13 gauge) to promote visibility and associated user safety. Since the glove has no seams on the back of the hand and is highly breathable, it reduces sweat and skin irritation. The excellent fit of the OP-280 provides continuous comfort over a long period of use. In addition, the premium latex coating improves abrasion resistance and has a long service life.

TYPE OF PROTECTION		APPLICATION	INFORMATION	
- General handling		INDUSTRIES Structural and civil engineering, self-employed trades, mechanical engineering, logistics, warehouse, waste treatment	COATING - Material: latex - Type: single, palm fit	SUPPORT MATERIAL - Gauge: 13 - Polyester - Color: neon yellow, red
NORMS		SIZES	PACKAGING	RRP €
EN388: 2016 2131X		With tag: 7/S; 8/M; 9/L; 10/XL; 11/XXL No tag: 7/S; 8/M; 9/L; 10/XL; 11/XXL	- 1 pair/polybag 144 pairs/box - 12 pairs/polybag 144 pairs/box	3,99 47,99



ALL MODELS AT A GLANCE



	WG-333	WG-333+	WG-522W	WG-522B	WG-422	WG-555	WG-500	WG-355	WG-1855HY	WG-300	WG-310HY	WG-310HO	WG-310R	OP-650	OP-650B	OP-650R	OP-280HY	OP-280RR	OP-1300	
General handling	✓	✓	✓	✓	✓	✓	✓	✓	✓	✓	✓	✓	✓	✓	✓	✓	✓	✓	✓	✓
Cut resistance	✓	✓																		
Liquids																				
Industrial oils																				
Cold	✓	✓																		
Heat	✓	✓	✓	✓	✓	✓														
Chemicals																				
Cut resistance level B	✓																			
Cut resistance level C																				
Cut resistance level D																				
Cut resistance level E																				
EN 388: 2016	3X42B	3X42B	4121X	4121X	3131X	4121X	4131X	2131X	4121X	2131X	2131X	2131X	2131X	4121X	4121X	4121X	2131X	2131X	4141X	
EN 374: 2016						✓			✓											
EN 407: 2004	X2XXXX	X2XXX	X1XXXX	X1XXXX	X1XXXX				X1XXXX											X1XXXX
EN 511: 2006	X1X	X1X																		

PROTECTION

NORMS

LEGEND

NORMS

- EN 388:2016**
Protection against physical and mechanical risks
- EN 511:2006**
Protection against cold
- EN 407:2004**
Protection against thermal risks
- EN 374:2016**
Protection against chemicals

CUT RESISTANCE

- Level A:**
High risk
- Level B & C:**
Medium risk
- Level D:**
Low risk
- Level E & F:**
Specific applications and very low risk

MATERIALS

- LTX:** latex
- NBR:** nitrile

BEFORE:
EN 388:2003



ABCD

CURRENT:
EN 388:2016



ABCDE (P)

X - no test was performed in this criterion

Impact resistance	(P)
Cut resistance (ISO 13997)	(A-F)
Puncture resistance	(0-4)
Tear resistance	(0-4)
Cut resistance (Coupe test)	(0-5)
Abrasion resistance	(0-4)

DIN EN 511: PROTECTION AGAINST COLD

DIN EN 511 regulates the protection of hands against cold. A distinction is made between convective cold (penetrating cold) and contact cold (e.g. through direct contact with cold objects). The waterproofness is also tested.

The higher the digit, the better the test result.



231

Test criteria	Performance level
Convective cold	Level 0-4
Contact cold	Level 0-4
Watertightness	Level 0-1

THERMAL RISKS

The higher the digit, the better the test result.



3121X2

Test criteria	Performance level
Burning behavior	Level 0-4
Contact heat	Level 0-4
Convective heat	Level 0-3
Radiant heat	Level 0-4
Exposure to small splashes of molten metal	Level 0-4
Exposure to big splashes of molten metal	Level 0-4



CUT RESISTANCE

Our gloves provide maximum safety in hazardous environments: depending on the application, each model combines a specific cut resistance level with innovative materials and Wonder Grip® technologies - from an extra-reinforced area between the thumb and index finger to innovative coatings that protect against temperatures, oils and chemicals. Some gloves can also be used to operate touch-screens.

TYPE OF PROTECTION

CUT RESISTANCE, COLD RESISTANCE,
HEAT RESISTANCE, LIQUIDS

INDUSTRIES

AUTOMOTIVE INDUSTRY
STAMPING
GLASS INDUSTRY
MACHINERY
HANDLING OF VERY SHARP OBJECTS
OR PARTS
METALLURGY
PETROCHEMISTRY
RECYCLING
IRON AND STEEL INDUSTRY
SORTING OF PARTS





WG-718 DEXCUT®

Tsunoooga®



The WG-718 Dexcute® is a glove with a triple nitrile coating on a 13 gauge knitted spandex, Tsunoooga™ high performance polyethylene and mineral fibre lining. The high-performance polyethylene Tsunoooga™ fibre offers excellent cut resistance (ISO 13997 level D) and outstanding flexibility while leaving the skin feeling fresh. The WG-718 is 100% impervious to industrial oils and liquids, making it the ideal protection for intensive use in very oily or very humid environments.

TYPE OF PROTECTION	APPLICATION	INFORMATION	
- Liquids - Cut resistance - Industrial oils	INDUSTRIES Automotive industry, stamping, glass industry, mechanical industry, handling of very sharp objects or parts, metallurgy, petrochemicals, recycling, iron and steel, part sorting	COATING - Material: nitrile - Type: triple, fully coated knitted cuff	SUPPORT MATERIAL - Gauge: 13 - Spandex - Tsunoooga™ - Mineral fibre - Color: dark red
NORMS		SIZES	PACKAGING
		With tag: 7/S; 8/M; 9/L; 10/XL; 11/XXL No tag: 7/S; 8/M; 9/L; 10/XL; 11/XXL	- 1 pair/polybag 144 pairs/box - 12 pairs/polybag 144 pairs/box
			RRP € 14,99 179,99



WG-733 DEXCUT®



The Dexcute® WG-733 is designed for heavy work in dry or slightly greasy environments involving medium to heavy cut hazards. The HDML™ coating, specially developed by Wonder Grip®, ensures a non-slip surface, exceptional anti-wear properties and a double protection against thermal hazards. The comprehensive set of protection encapsulated in our unique WG-733 makes it the ultimate glove for all-round use in semi-dry environments.

TYPE OF PROTECTION	APPLICATION	INFORMATION	
- Liquids - Cut resistance - Industrial oils	INDUSTRIES Construction and public works, metal construction, road maintenance, green spaces, recycling	COATING - Material: latex - Type: double, short 3/4 cuff	SUPPORT MATERIAL - Gauge: 10 - Spandex - Polyester - Steel Wire - Mineral fibre - Color: green
NORMS		SIZES	PACKAGING
		With tag: - No tag: 7/S; 8/M; 9/L; 10/XL; 11/XXL	- 1 pair/polybag 144 pairs/box - 12 pairs/polybag 144 pairs/box
			RRP € 9,99 119,99



WG-733+ DEXCUT®

Tsunoooga®



The Dexcute® WG-733+ is designed for heavy work in dry or slightly greasy environments involving medium to heavy cut hazards. The HDML™ coating, specially developed by Wonder Grip®, ensures a non-slip surface, exceptional anti-wear properties and a double protection against thermal hazards. The comprehensive set of protection encapsulated in our unique WG-733+ makes it the ultimate glove for all-round use in semi-dry environments.

TYPE OF PROTECTION	APPLICATION	INFORMATION	
- Cut resistance - Heat resistance - Cold resistance - Liquids - Industrial oils	INDUSTRIES Construction and public works, metallurgy, public authorities, waste management	COATING - Material: latex - Type: double, short 3/4cuff	SUPPORT MATERIAL - Gauge: 10 - Spandex - Tsunoooga™ - Mineral fibre - Color: green
NORMS		SIZES	PACKAGING
		With tag: - No tag: 7/S; 8/M; 9/L; 10/XL; 11/XXL	- 1 pair/polybag 144 pairs/box - 12 pairs/polybag 144 pairs/box
			RRP € 10,99 131,99



WG-780 DEXCUT®



The WG-780 Dexcute® is a glove with a single nitrile coating on the palm and a knitted 10 gauge inner lining of aramid, acrylic, spandex and mineral fibers. The WG-780 is the ideal solution for all work environments with thermal risks and the risk of cuts. Thanks to our specially developed SZNT™, it ensures very good flexibility even in extreme cold down to -20 °C. Thanks to its cut resistance (EN 388:2016 level D), this glove offers excellent protection in cold environments.

TYPE OF PROTECTION	APPLICATION	INFORMATION	
- Cut resistance - Heat resistance	INDUSTRIES Agriculture, construction and public works, public authorities, metal construction, snow clearing, refrigerated warehouses, road maintenance, green spaces, glass and metallurgy industries	COATING - Material: nitrile - Type: single, palm fit	SUPPORT MATERIAL - Gauge: 10 - Spandex - Acrylic - Aramid - Mineral fibre - Color: blue
NORMS	SIZES	PACKAGING	RRP €
EN388: 2016 4X32D EN511: 2006 X1X ANSI A3 CUT CE	With tag: XL/10 No tag: 7/S; 8/M; 9/L; 10/XL; 11/XXL	- 1 pair/polybag 72 pairs/box - 12 pairs/polybag 72 pairs/box	15,99 191,99



OP-775 OPTY™



The Wonder Grip® Opty™ OP-775 is the perfect glove for any user seeking a solution that combines cut resistance (ISO13997 level C and ANSI A3) with abrasion resistance. Ideal for working in dry environments, this protective glove features extra-dense polyethylene fabric and our premium Xtended Performances XPI™ coating for a superior fit and solid grip. Thanks to the ventilated back of the glove breathability is guaranteed: the hands stay pleasantly dry.

TYPE OF PROTECTION	APPLICATION	INFORMATION	
- Cut resistance	INDUSTRIES Aerospace, automotive industry, stamping, industry, glass industry, mechanical engineering, handling of sharp parts or objects in dry environments	COATING - Material: PU - Type: single, palm fit	SUPPORT MATERIAL - Gauge: 13 - Spandex - Polyester - HPPE - Mineral fibre - Color: grey
NORMS	SIZES	PACKAGING	RRP €
EN388: 2016 4X43C ANSI A3 CUT CE	With tag: - No tag: 7/S; 8/M; 9/L; 10/XL; 11/XXL	- 1 pair/polybag 144 pairs/box - 12 pairs/polybag 144 pairs/box	6,99 83,99



WG-788 DEXCUT®

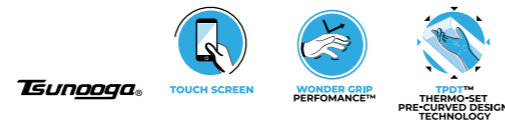

The WG-788 Dexcute® is a single nitrile coated glove with a 13 gauge inner lining of HPPE, mineral fiber and spandex with high cut resistance (ISO 13997 level D) while providing unrivaled flexibility and comfort. The WG-788 Dexcute® is made of Tsunooga™ high performance polyethylene fibers to provide excellent cut resistance as well as very good flexibility and maximum comfort. In addition, the WG-788 benefits from our Wonder Grip Performance™ coating, which provides high heat resistance (EN 407:2004 X1XXXX) and superior grip. Touchscreens and smartphones can be easily operated with the WG-788.

TYPE OF PROTECTION	APPLICATION	INFORMATION	
- Cut resistance - Heat resistance	INDUSTRIES Automotive, recycling, metallurgy, assembly, industrial maintenance, sorting, installation and handling of very sharp parts or objects, steel industry	COATING - Material: nitrile - Type: single, palm fit	SUPPORT MATERIAL - Gauge: 13 - Spandex - Polyester - Tsunooga™ - Mineral fibre - Color: green
NORMS	SIZES	PACKAGING	RRP €
EN388: 2016 4X42D EN407: 2004 X1XXXX ANSI A4 CUT CE	With tag: - No tag: 7/S; 8/M; 9/L; 10/XL; 11/XXL	- 1 pair/polybag 144 pairs/box - 12 pairs/polybag 144 pairs/box	12,99 155,99



OP-795 OPTY™



The Wonder Grip® Opty™ OP-795 is engineered to offer protection against the risks of severe cuts (ISO13997 level E and ANSI A5) without compromising comfort. With its flexible cut resistant outer shell and premium Xtended Performances XPI™ coating, the OP-795 fits smoothly and provides a solid grip in dry environments. Thanks to the ventilated back of the glove, good breathability is also guaranteed.

TYPE OF PROTECTION	APPLICATION	INFORMATION	
- Cut resistance	INDUSTRIES Aerospace, automotive industry, stamping, industry, glass industry, mechanical engineering, handling of very sharp parts or objects in dry environments	COATING - Material: PU - Type: single, palm fit	SUPPORT MATERIAL - Gauge: 13 - Spandex - Polyester - HPPE - Mineral fibre, Steel wire - Color: Grey
NORMS	SIZES	PACKAGING	RRP €
EN388: 2016 4X43E ANSI A5 CUT CE	With tag: - No tag: 7/S; 8/M; 9/L; 10/XL; 11/XXL	- 1 pair/polybag 144 pairs/box - 12 pairs/polybag 144 pairs/box	11,99 143,99

ALL MODELS AT A GLANCE



PROTECTION

NORMS

	WG-718	WG-733	WG-780	WG-788	WG-733+	OP-775	OP-795
General handling							
Cut resistance	✓	✓	✓	✓	4X43D	✓	✓
Liquids	✓				✓		
Industrial oils	✓				✓		
Cold		✓	✓		✓		
Heat		✓		✓	✓		
Chemicals							
Cut resistance level B							
Cut resistance level C						✓	
Cut resistance level D	✓	✓	✓	✓			
Cut resistance level E							✓
EN 388: 2016	4X43D	4X43D	4X43D	4X43D	4X43D	4X43C	4X43E
EN 374: 2016							
EN 407: 2004		X2XXXX		X1XXXX	X2XXXX		
EN 511: 2006		X1X	X1X		X1X		
Suitable for handling food	✓						

LEGEND

NORMS

- EN 388:2016**
Protection against physical and mechanical risks
- EN 511:2006**
Protection against cold
- EN 407:2004**
Protection against thermal risks
- EN 374:2016**
Protection against chemicals

CUT RESISTANCE

- Level A:**
High risk
- Level B & C:**
Medium risk
- Level D:**
Low risk
- Level E & F:**
Specific applications and very low risk

MATERIALS

- LTX:** latex
- NBR:** nitrile

BEFORE:
EN 388:2003



ABCD

CURRENT:
EN 388:2016



ABCDE (P)

X - no test was performed in this criterion

Impact resistance	(P)
Cut resistance (ISO 13997)	(A-F)
Puncture resistance	(0-4)
Tear resistance	(0-4)
Cut resistance (Coupe test)	(0-5)
Abrasion resistance	(0-4)

DIN EN 511: PROTECTION AGAINST COLD

DIN EN 511 regulates the protection of hands against cold. A distinction is made between convective cold (penetrating cold) and contact cold (e.g. through direct contact with cold objects). The waterproofness is also tested.

The higher the digit, the better the test result.



231

Test criteria	Performance level
Convective cold	Level 0-4
Contact cold	Level 0-4
Watertightness	Level 0-1

THERMAL RISKS

The higher the digit, the better the test result.



3121X2

Test criteria	Performance level
Burning behavior	Level 0-4
Contact heat	Level 0-4
Convective heat	Level 0-3
Radiant heat	Level 0-4
Exposure to small splashes of molten metal	Level 0-4
Exposure to big splashes of molten metal	Level 0-4



WATER RESISTANCE

For endless uses from gardening to food production, wet or dry: a double latex full coating keeps hands 100% dry and, in combination with our innovative technologies, gives them enough freedom of movement and grip.

TYPE OF PROTECTION

LIQUIDS

INDUSTRIES

FOOD INDUSTRY
SELF-EMPLOYED TRADES
CIVIL ENGINEERING
PUBLIC FACILITIES
CONSTRUCTION
GREEN SURFACES
AGRICULTURAL INDUSTRY
WASTE TREATMENT

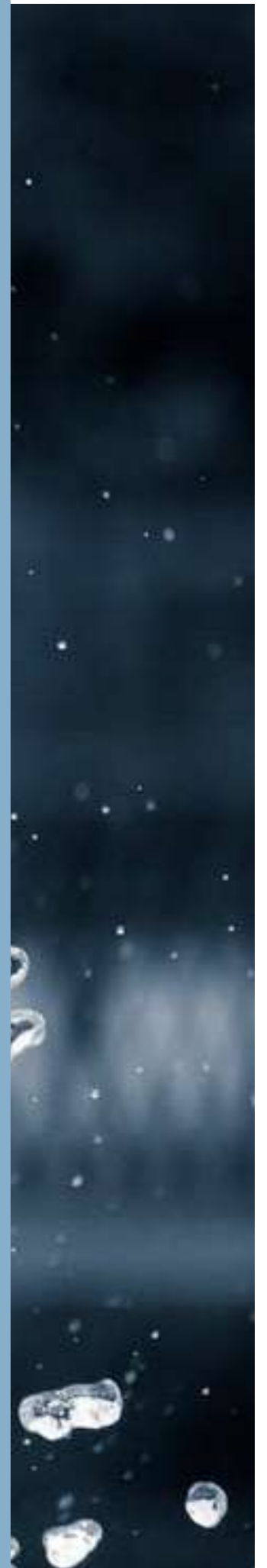



WG-318 AQUA

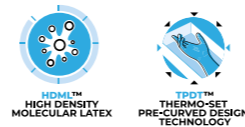

The WG-318 Aqua is a double fully coated latex glove with a 13 gauge nylon lining. Thanks to Wonder Grip Technology™, the coating provides unparalleled grip and strength in dry or wet environments. The WG-318 Aqua is 100% waterproof and keeps the user's hands dry and comfortable. In terms of grip and flexibility, it is our preferred glove for wet environments. It guarantees comfort and grip while maintaining excellent flexibility.

TYPE OF PROTECTION	APPLICATION	INFORMATION	
- General handling - Liquids	INDUSTRIES Agrifood, self-employed trades, construction and public works, public authorities, construction, green spaces, agricultural industry, waste treatment	COATING - Material: Latex - Type: double, fully coated knitted cuff	SUPPORT MATERIAL - Gauge: 13 - Nylon - Color: blue, orange cuff
NORMS	SIZES	PACKAGING	RRP €
EN388: 2016 3141X 	With tag: 7/S; 8/M; 9/L; 10/XL; 11/XXL No tag: 7/S; 8/M; 9/L; 10/XL; 11/XXL	- 1 pair/polybag 144 pairs/box - 12 pairs/polybag 144 pairs/box	5,99 71,99

Suitable for handling food	✓
Food safe	✓



NORMS

- EN 388:2016**
Protection against physical and mechanical risks
- EN 511:2006**
Protection against cold
- EN 407:2004**
Protection against thermal risks
- EN 374:2016**
Protection against chemicals

CUT RESISTANCE

- Level A:**
High risk
- Level B & C:**
Medium risk
- Level D:**
Low risk
- Level E & F:**
Specific applications and very low risk

MATERIALS

LTX: latex
NBR: nitrile

BEFORE: EN 388:2003 **CURRENT: EN 388:2016**

ABCD **ABCDE (P)**

Impact resistance	(P)
Cut resistance (ISO 13997)	(A-F)
Puncture resistance	(0-4)
Tear resistance	(0-4)
Cut resistance (Coupe test)	(0-5)
Abrasion resistance	(0-4)

X - no test was performed in this criterion

DIN EN 511: PROTECTION AGAINST COLD

DIN EN 511 regulates the protection of hands against cold. A distinction is made between convective cold (penetrating cold) and contact cold (e.g. through direct contact with cold objects). The waterproofness is also tested.

The higher the digit, the better the test result.

EN 511



Test criteria	Performance level
Convective cold	Level 0-4
Contact cold	Level 0-4
Watertightness	Level 0-1

THERMAL RISKS

The higher the digit, the better the test result.

EN 407



Test criteria	Performance level
Burning behavior	Level 0-4
Contact heat	Level 0-4
Convective heat	Level 0-3
Radiant heat	Level 0-4
Exposure to small splashes of molten metal	Level 0-4
Exposure to big splashes of molten metal	Level 0-4



CHEMICAL RESISTANCE

Dry, moist or oily environments: our gloves reliably protect against chemicals and other liquids - and are particularly grippy thanks to their innovative coating. The extra-long cuff can be folded back to catch hazardous substances.

TYPE OF PROTECTION

LIQUIDS, CHEMICALS,
INDUSTRIAL OILS, CUT PROTECTION

INDUSTRIES

AGRICULTURE
SELF-EMPLOYED TRADES
CIVIL ENGINEERING
PUBLIC FACILITIES
CONSTRUCTION
ROAD MAINTENANCE
GREEN SPACES
WATER RESOURCES MANAGEMENT
INDUSTRY
AGRIBUSINESS
LOGISTICS
PETROCHEMISTRY
SEWAGE TREATMENT PLANTS
WASTE TREATMENT





WG-758L DEXCUT®

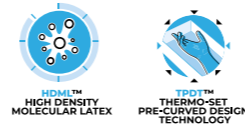

The WG-758L Dexcute® is designed to meet today's demanding and increasingly complex work environments. Our WG-758L is based on a 15 gauge inner liner and features a cut-resistant nitrile outer shell for exceptional dexterity and tactile feel compared to industry standards. The WG-758L has been certified as chemical and cut resistant. The combination of a nitrile coating with Wonder Grip Technology™ and our Thermo-set Pre-Curved Design Technology™ (TPDT™) pre-fabricated molds makes the WG-758L the perfect solution with superior ergonomic properties and unsurpassed grip in slippery environments.

TYPE OF PROTECTION	APPLICATION	INFORMATION	
- Cut resistance - Liquids - Chemical - Industrials oils	INDUSTRIES Agricultural industry, petrochemicals, sewage treatment plants, waste treatment	COATING - Material: nitrile - Type: triple, long cuff	SUPPORT MATERIAL - Gauge: 15 - Spandex - Polyester - HPPE - Color: blue
NORMS		SIZES	PACKAGING
		With tag: - No tag: 7/S; 8/M; 9/L; 10/XL; 11/XXL	- 1 pair/polybag 72 pairs/box - 12 pairs/polybag 72 pairs/box
			RRP € 16,99 203,99



OP-600L OPTY™

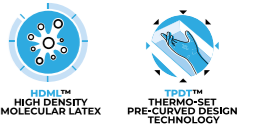

The OPTY™ OP-600L model is our new protective glove against chemical risks in dry, oily or humid environments. Thanks to the rough finish on the palm, it offers excellent grip in any environment. The triple PVC coating ensures perfect resistance to oils. The seamless cotton inner lining provides unparalleled dexterity.

EN 374-1: A/J / A = Methanol / J = n-Heptane / K= Sodium Hydroxide 40%

TYPE OF PROTECTION	APPLICATION	INFORMATION	
- Liquids - Chemical - Industrials oils	INDUSTRIES Agriculture, self-employed trades, construction and public works, public authorities, construction, road maintenance, green spaces, aquatic resource management, industry, agricultural industry, logistics, petrochemicals, sewage treatment plants, waste treatment, agricultural work	COATING - Material: PVC - Type: triple, long Cuff	SUPPORT MATERIAL - Gauge: 13 - Cotton - Color: blue
NORMS		SIZES	PACKAGING
		With tag: 8/M; 9/L; 10/XL; 11/XXL No tag: -	- 1 pair/polybag 72 pairs/box - 12 pairs/polybag 72 pairs/box
			RRP € 5,99



ALL MODELS AT A GLANCE



WG-758L

OP-600L

PROTECTION: General handling, Cut resistance, Liquids, Industrial oils, Cold, Heat, Chemicals

NORMS: EN 388:2016, EN 374:2016, EN 407:2004, EN 511:2006, suitable for handling food

General handling	WG-758L	OP-600L
Cut resistance	✓	
Liquids	✓	✓
Industrial oils	✓	✓
Cold		
Heat		
Chemicals	✓	✓
Cut resistance level B		
Cut resistance level C		
Cut resistance level D		
Cut resistance level E		
EN 511:2006		
EN 407:2004		
EN 374:2016	AJK	AJK
EN 388:2016	4X44C	4I21X

LEGEND

NORMS

- EN 388:2016**
Protection against physical and mechanical risks
- EN 511:2006**
Protection against cold
- EN 407:2004**
Protection against thermal risks
- EN 374:2016**
Protection against chemicals

CUT RESISTANCE

- Level A:**
High risk
- Level B & C:**
Medium risk
- Level D:**
Low risk
- Level E & F:**
Specific applications and very low risk

MATERIALS

- LTX:** latex
- NBR:** nitrile

BEFORE: EN 388:2003 (ABCD) vs **CURRENT: EN 388:2016** (ABCDE(P))

Impact resistance	(P)
Cut resistance (ISO 13997)	(A-F)
Puncture resistance	(0-4)
Tear resistance	(0-4)
Cut resistance (Coupe test)	(0-5)
Abrasion resistance	(0-4)

X - no test was performed in this criterion

DIN EN 511: PROTECTION AGAINST COLD

DIN EN 511 regulates the protection of hands against cold. A distinction is made between convective cold (penetrating cold) and contact cold (e.g. through direct contact with cold objects). The waterproofness is also tested.

The higher the digit, the better the test result.

EN 511



2 3 1

Test criteria	Performance level
Convective cold	Level 0-4
Contact cold	Level 0-4
Watertightness	Level 0-1

THERMAL RISKS

The higher the digit, the better the test result.

EN 407



3 1 2 1 X 2

Test criteria	Performance level
Burning behavior	Level 0-4
Contact heat	Level 0-4
Convective heat	Level 0-3
Radiant heat	Level 0-4
Exposure to small splashes of molten metal	Level 0-4
Exposure to big splashes of molten metal	Level 0-4



INDUSTRIAL OIL RESISTANCE

Strong, grippy, flexible and particularly durable: the double to triple nitrile coating of our gloves forms a strong protective layer against grease and oil. At the same time, it is particularly abrasion-resistant and gives the hands plenty of freedom of movement and grip - ideal for precise work that requires a lot of dexterity.

TYPE OF PROTECTION

LIQUIDS, INDUSTRIAL OILS

INDUSTRIES

AUTOMOTIVE INDUSTRY

PUBLIC FACILITIES

MAINTENANCE

GENERAL HANDLING IN HUMID, VERY GREASY OR VERY OILY ENVIRONMENTS

SEWAGE TREATMENT PLANTS

REFRIGERATION SYSTEMS

REFRIGERATED TRANSPORT AND STORAGE

SORTING OF PARTS

PROCESSING

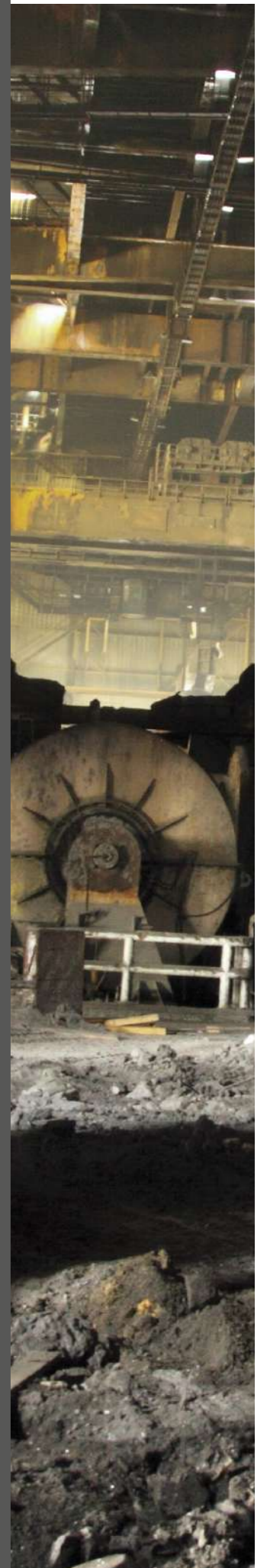



WG-510 OIL

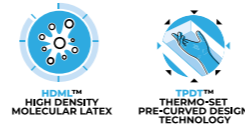

The WG-510 Oil is based on a 13 gauge nylon and spandex liner and features a double nitrile coating. This double coating allows excellent protection against oils, prevents their permeation into the glove and provides additional abrasion resistance. The WG-510 Oil allows for easy hand movement and ensures excellent flexibility with pleasantly cool hands.

TYPE OF PROTECTION	APPLICATION	INFORMATION	
- General handling - Industrial oils	INDUSTRIES Automotive industry, maintenance, precision handling in greasy and oily environments, part sorting, machine tooling	COATING - Material: nitrile - Type: double, palm fit	SUPPORT MATERIAL - Gauge: 13 - Nylon - Spandex - Color: black
NORMS		SIZES	PACKAGING
EN388: 2016 4121X 		With tag: 8/M; 9/L; 10/XL; 11/XXL No tag: 7/S; 8/M; 9/L; 10/XL; 11/XXL	- 1 pair/polybag 144 pairs/box - 12 pairs/polybag 144 pairs/box
			RRP € 4,99 59,99



WG-528L OIL GUARD

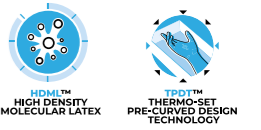

The WG-528L Oil Guard is constructed with a 15 gauge nylon liner and triple nitrile coating for unsurpassed abrasion and tear resistance + impermeability to industrial oils. The lightweight construction and soft finish of the WG-528L Oil Guard allow the user to maintain a high-level of dexterity while ensuring comfort. The WG-528L Oil Guard is the glove of choice for any user seeking a heavy-duty glove for damp and oily applications.

TYPE OF PROTECTION	APPLICATION	INFORMATION	
- Liquids - Industrial oils	INDUSTRIES Automotive industry, public authorities, maintenance, general handling in damp, very greasy and very oily environments, sewage treatment plants, refrigerated transport and storage, part sorting, machine tooling	COATING - Material: nitrile - Type: triple, long cuff	SUPPORT MATERIAL - Gauge: 15 - Nylon - Color: blue
NORMS		SIZES	PACKAGING
EN388: 2016 4132X 		With tag: 7/S; 8/M; 9/L; 10/XL; 11/XXL No tag: 7/S; 8/M; 9/L; 10/XL; 11/XXL	- 1 pair/polybag 72 pairs/box - 12 pairs/polybag 72 pairs/box
			RRP € 7,99 95,99



ALL MODELS AT A GLANCE



WC-510



WC-528L

PROTECTION

General handling
 Cut resistance
 Liquids
 Industrial oils
 Cold
 Heat
 Chemicals
 Cut resistance level B
 Cut resistance level C
 Cut resistance level D
 Cut resistance level E
 EN 388: 2016
 EN 374: 2016
 EN 407: 2004
 EN 511: 2006
 suitable for handling food

General handling	✓	
Cut resistance		
Liquids		✓
Industrial oils	✓	✓
Cold		
Heat		
Chemicals		
Cut resistance level B		
Cut resistance level C		
Cut resistance level D		
Cut resistance level E		
EN 388: 2016	4121X	4132X

LEGEND

NORMS

- EN 388:2016**
Protection against physical and mechanical risks
- EN 511:2006**
Protection against cold
- EN 407:2004**
Protection against thermal risks
- EN 374:2016**
Protection against chemicals

CUT RESISTANCE

- Level A:**
High risk
- Level B & C:**
Medium risk
- Level D:**
Low risk
- Level E & F:**
Specific applications and very low risk

MATERIALS

- LTX:** latex
- NBR:** nitrile

X - no test was performed in this criterion

BEFORE:
EN 388:2003



ABCD

CURRENT:
EN 388:2016



ABCDE (P)

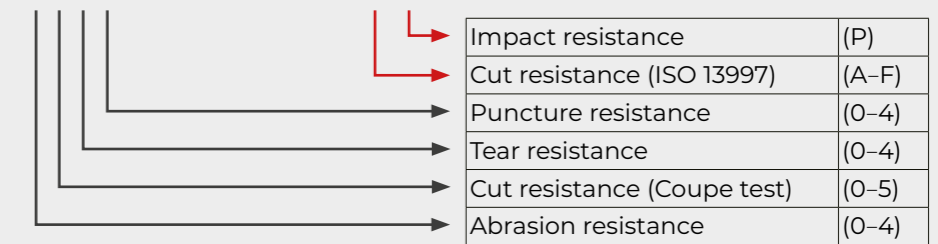

DIN EN 511: PROTECTION AGAINST COLD

DIN EN 511 regulates the protection of hands against cold. A distinction is made between convective cold (penetrating cold) and contact cold (e.g. through direct contact with cold objects). The waterproofness is also tested.

The higher the digit, the better the test result.

EN 511



231

Test criteria	Performance level
Convective cold	Level 0-4
Contact cold	Level 0-4
Watertightness	Level 0-1

THERMAL RISKS

The higher the digit, the better the test result.

EN 407



3121X2

Test criteria	Performance level
Burning behavior	Level 0-4
Contact heat	Level 0-4
Convective heat	Level 0-3
Radiant heat	Level 0-4
Exposure to small splashes of molten metal	Level 0-4
Exposure to big splashes of molten metal	Level 0-4

**WONDER
GRIP®**

Redefining Hand Protection

wondergrip.com in @

wentronic

Wentronic GmbH
Pillmannstraße 12, 38112 Braunschweig

www.wentronic.com